

Model Number: **ST7001SLIM, ST7001SLIMA**  
 Description: **SUPERTUB DBL DRW SLIM**  
 Bar Code: **9414930213354, 9414930213460**

## Typical design

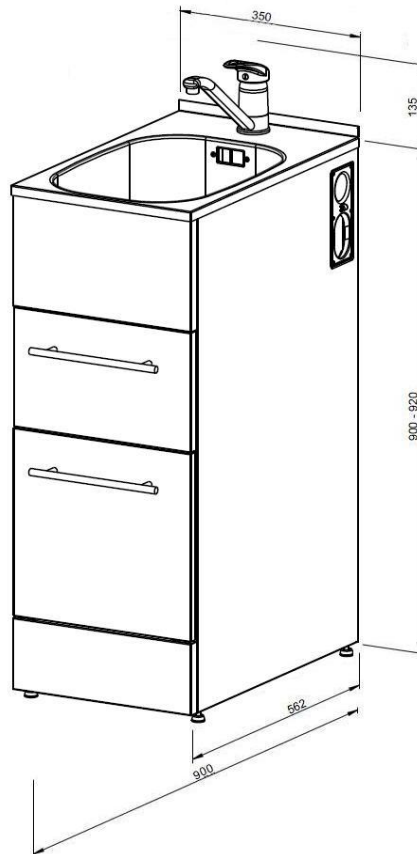

## Features and benefits

### Features

- Single lever tap suitable for all water pressure
- Spacious double draws
- Brushed steel handles
- Seamless stainless steel tub
- Powder coated galvanized steel cabinet
- Modern styling
- Ceramic mixer head technology
- Side apertures for hoses
- Supporting levelling feet
- P trap supplied and installed
- Hidden washing machine taps and shut-off valve
- Separate waste pipe for washing machine
- Improved plumbing components

### Benefits

- Ease of operation
- Easy organization and storage in the laundry
- Gives a cleaner more contemporary and modern look
- Long lasting and easy to clean
- Corrosion resistant for long life
- Compliments leading brands of washing machines
- Finger touch control of water flow
- Easy access for washing machine connections and hides unsightly hoses
- Ensure stability on uneven surfaces
- Allows the Supertub to be plumbed through either the wall or floor
- Allows a tap less console, giving a cleaner, more aesthetic appearance
- Allows washing machine to empty when tub is full
- Capable of working on all water pressure situations above 10 psi

## Specifications

### Technical data:

- Cabinet - 0.6mm galvanized sheet metal, powder coated. 24 months warranty
- Bowl – 0.8mm polished stainless steel bowl, 17 litre capacity. 5 years warranty
- Mixer - single lever ceramic cartridge. 24 months warranty
- Plastic parts - ABS UV (ultra violet sun protection)
- Waste plumbing connections - standard 40mm P trap supplied and installed.
- Water connections – 400mm long flexible braided hoses, supplied and installed.
- WELS rating 3 star rated (Australia): 7.8 litres per minute

**Nett Weight:** 24.15 kg

**Carton Weight:** 26 kg

**Carton Dimension (mm):** 389 x 630 x 970 (w x d x h)

**Volume (m3):** 0.232 m<sup>3</sup>

### Performance data:

- Designed and manufactured to perform in all water pressure situations above 10 psi
- See table below for examples of time taken to fill a 30 litre tub

| Pressure (Psi) | Flow Rate (L/min) | Time 30 litre bowl (Minutes) |
|----------------|-------------------|------------------------------|
| 10             | 5.08              | 5.54                         |
| 20             | 6.86              | 4.23                         |
| 65*            | 11.13             | 2.42                         |

\* Typical household pressure

How to measure your water flow in your home. (measuring jug, watch)

Place a one litre measuring jug under the faucet, with your watch ready open the cold water, when the jug is full confirm the time on the watch in seconds. Multiply this number by 30 for a 30 litre bowl.

Example 1 litre jug fills in 8 seconds x 30 litres = 240 seconds divide by 60 for minutes equals 4 minutes  
Approx 65 Psi.

Example 1 litre jug fills in 12 seconds x 30 litres = 360 seconds divide by 60 for minutes equals 6 minutes  
Approx 20 Psi.

Repeat for the hot water, if the results are the same it will confirm that the pressure is equal.

| Hot Pressure | Cold Pressure | Known As | Suitable |
|--------------|---------------|----------|----------|
| Low          | Low           | Low      | Yes      |
| High         | High          | Mains    | Yes      |
| Low          | High          | Unequal  | Yes      |
| High         | Low           | Unequal  | Yes*     |

\* Will require non return valve to be swapped from hot to cold side.

## Plan view Dimensions

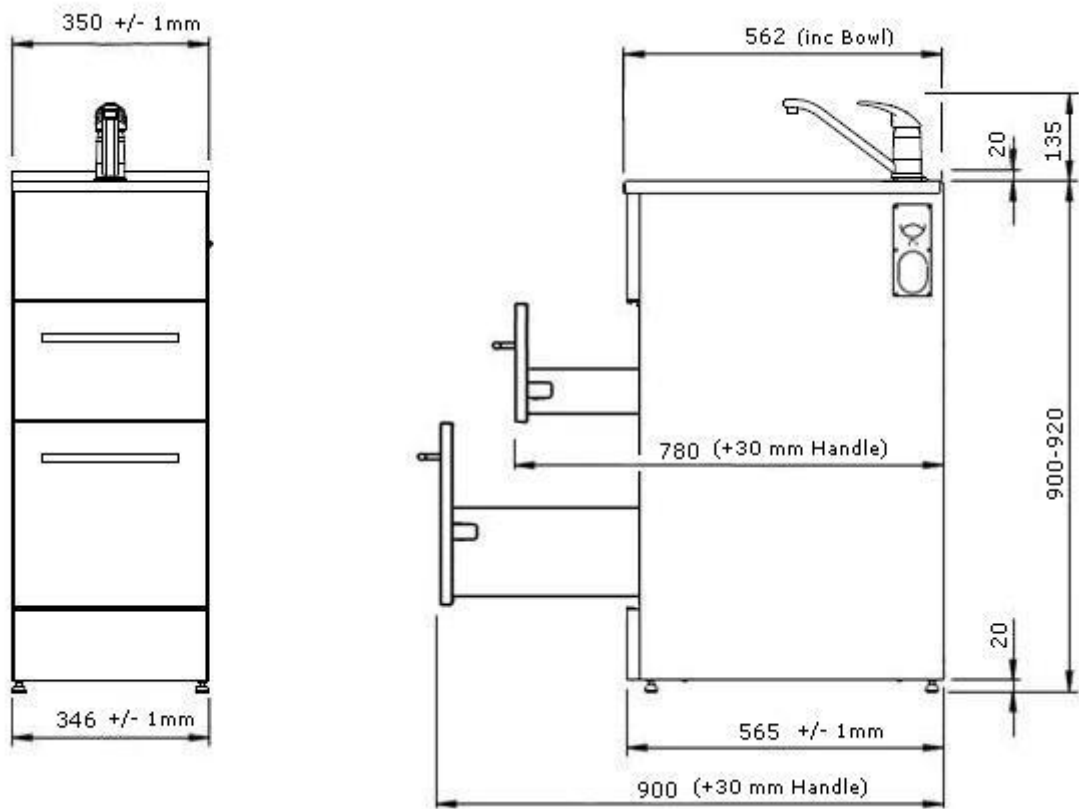

## Drawer and Bowl Dimensions

Top Drawer

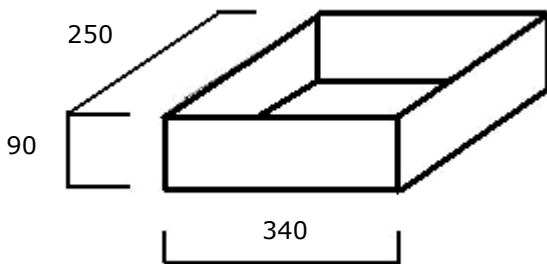

The tub detail to the top of the tub volume is 22 litres

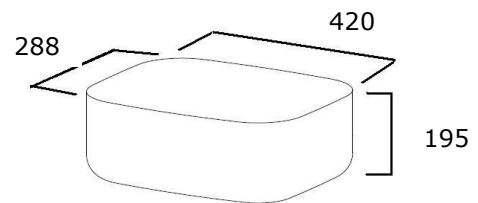

The detail to the bottom of the overflow volume is 17 litres

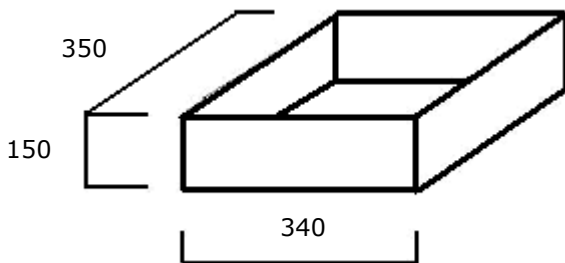
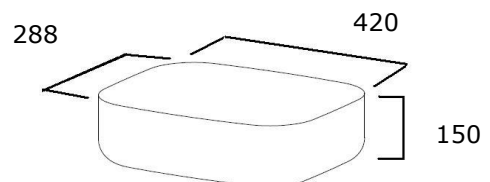

Bottom Drawer

## Fit Out Detail Side View

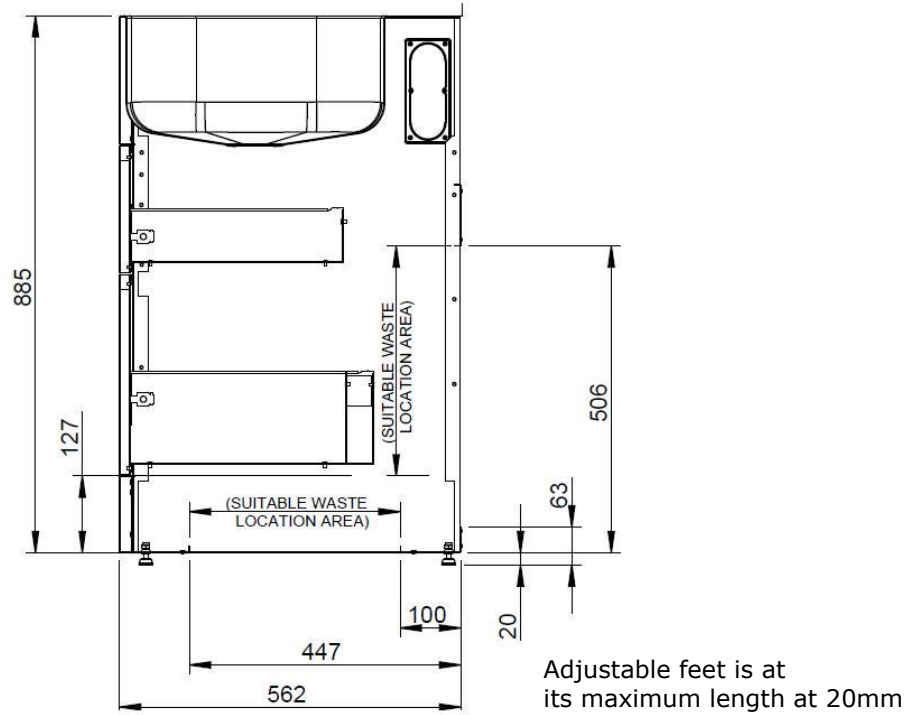

## Fit Out Detail Front View

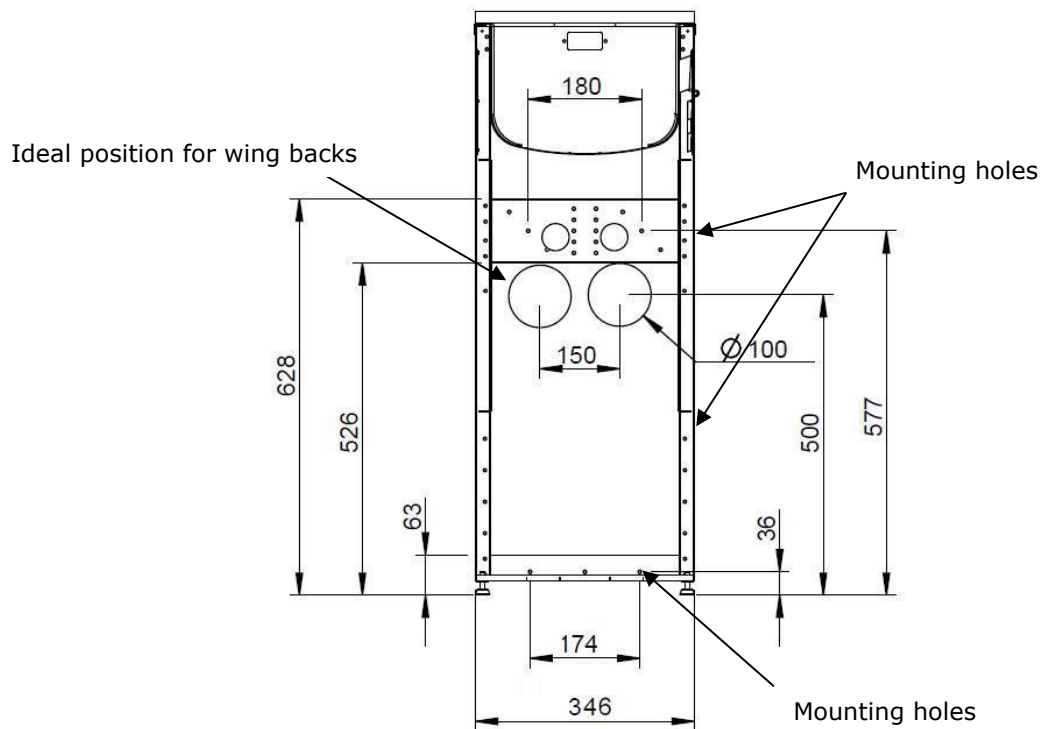

### New Zealand

Monaco Corporation Ltd  
 Telephone: (09) 415 6000  
 Facsimile: (09) 415 7400  
 Email: [enquiries@robinhood.co.nz](mailto:enquiries@robinhood.co.nz)  
[www.robinhood.co.nz](http://www.robinhood.co.nz)

### Australia

Shriro Australia Pty Ltd  
 ABN 28 002 386 129  
 Telephone: 1800 648 556  
 Facsimile: 1800 628 577  
 Email: [enquiries@robinhood.com.au](mailto:enquiries@robinhood.com.au)  
[www.robinhood.com.au](http://www.robinhood.com.au)